



Expand Grand Fabric Wall R 175



Bestandteile

- Expand Grand Fabric Wall R 175
- Beleuchtung
- Transporttrolley



Expand Grand Fabric Wall R 175

Horizontal Pole

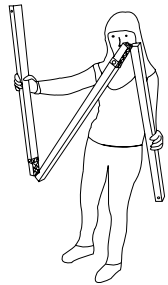

x2

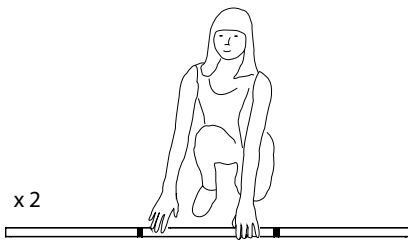

Vertical Pole

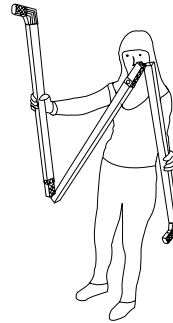

x2

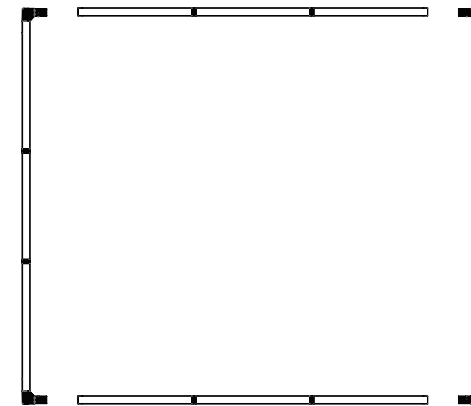
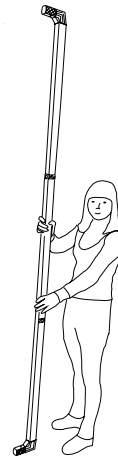

Click!

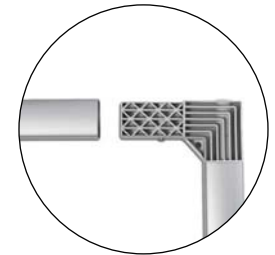



Expand Grand Fabric Wall R 175

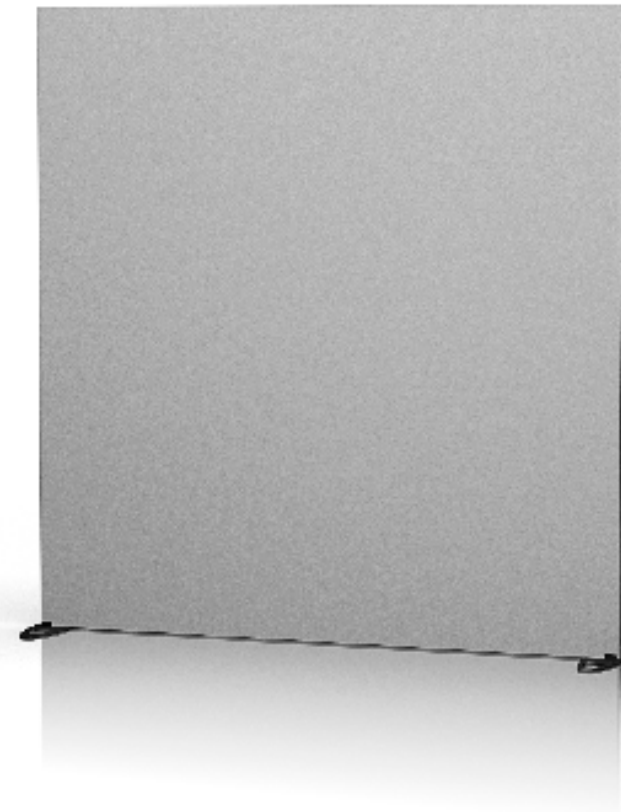
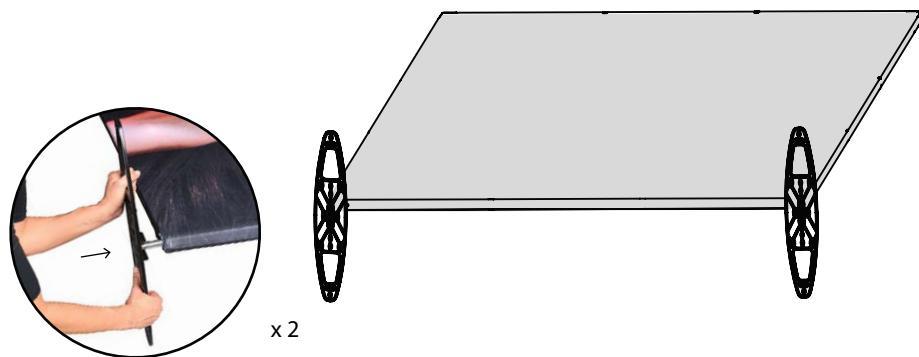
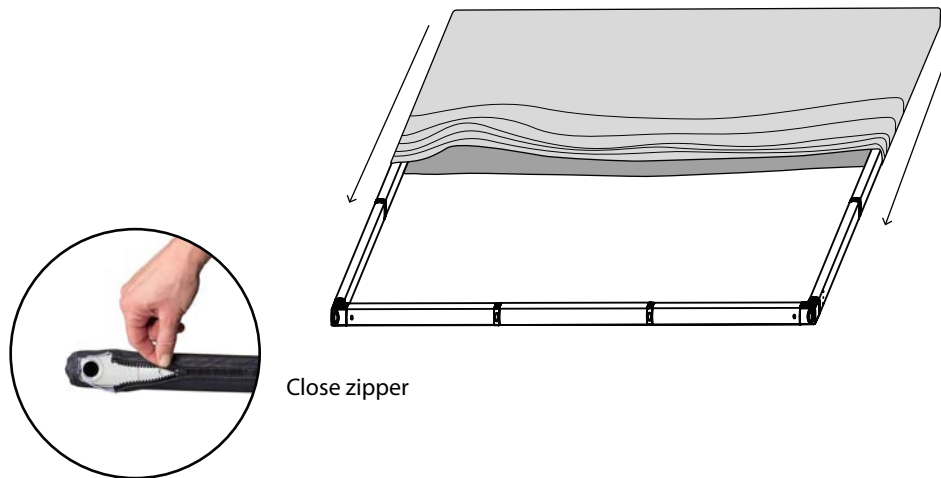



Expand Grand Fabric Wall R 175

Haben Sie noch Fragen?

Sie erreichen uns jeden Montag bis Freitag von 9 - 17 Uhr.

X-CITE Werbesysteme GmbH

Vilbeler Landstr. 7

D-60386 Frankfurt am Main

Tel.: +49 (0) 69 150 49 30 - 00

Fax: +49 (0) 69 150 49 30 - 29

E-Mail: sales@x-cite.com

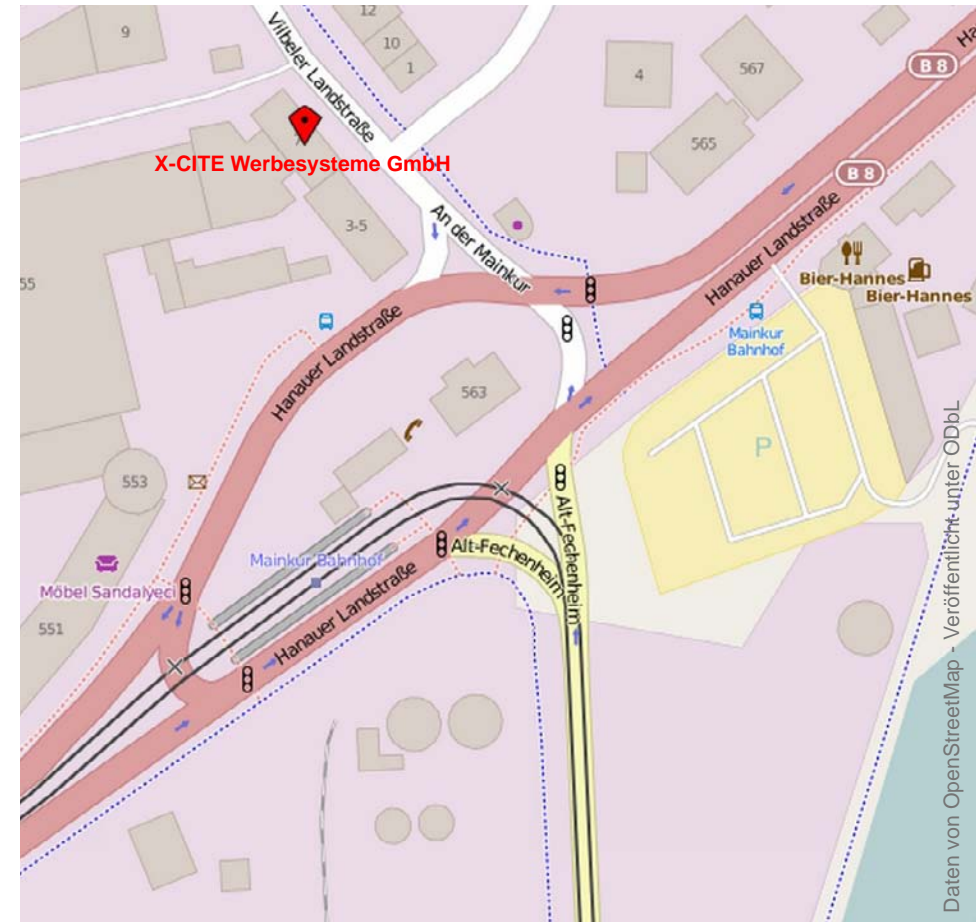

► [In Google-Maps öffnen](#)