



## Expand Grand Fabric Wall G 230



### Bestandteile

- Expand Grand Fabric Wall G 230
- Auslegerfüße
- Beleuchtung
- Transporttrolley



## Expand Grand Fabric Wall G 230

Horizontal Pole

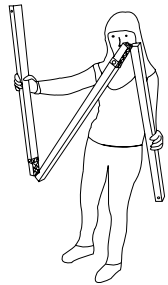

x2

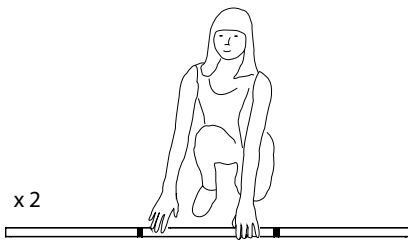

Vertical Pole

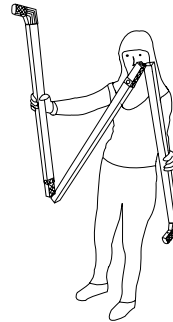

x2

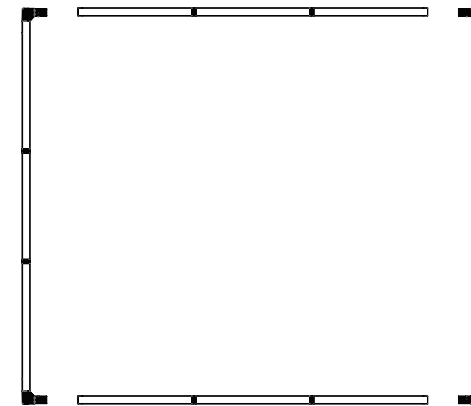
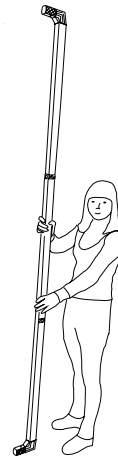

Click!

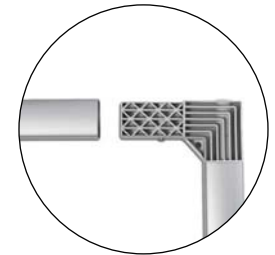



## Expand Grand Fabric Wall G 230

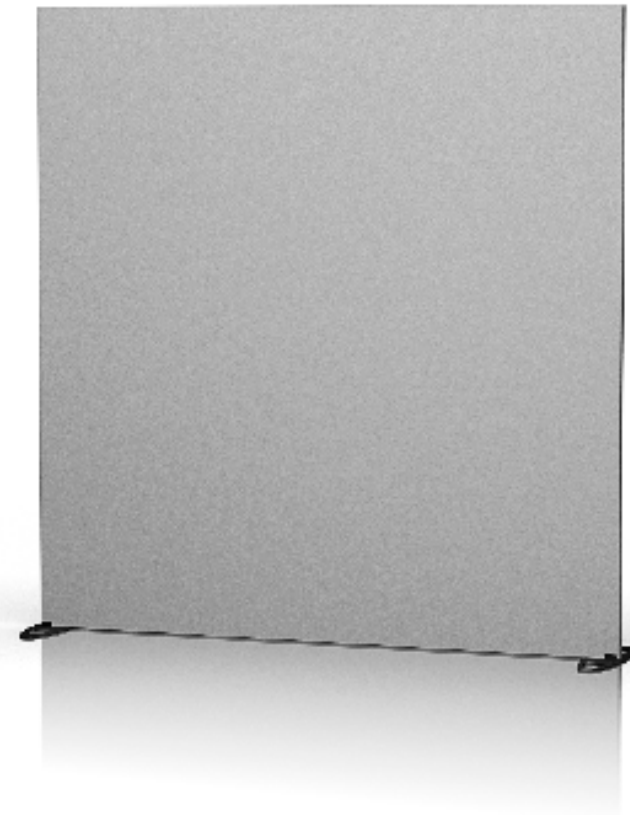
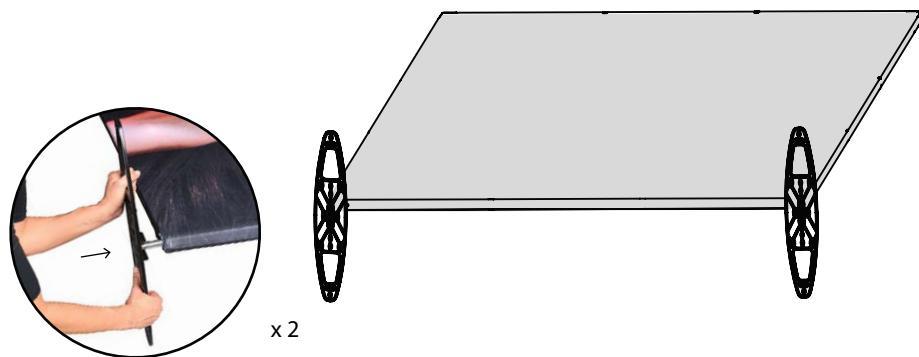
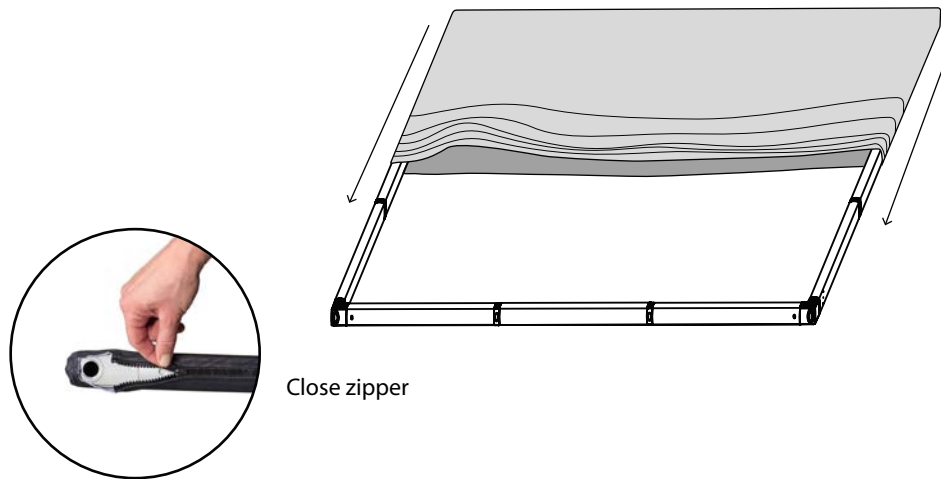



## Expand Grand Fabric Wall G 230

### Haben Sie noch Fragen?

Sie erreichen uns jeden Montag bis Freitag von 9 - 17 Uhr.

### X-CITE Werbesysteme GmbH

Vilbeler Landstr. 7

D-60386 Frankfurt am Main

Tel.: +49 (0) 69 150 49 30 - 00

Fax: +49 (0) 69 150 49 30 - 29

E-Mail: [sales@x-cite.com](mailto:sales@x-cite.com)

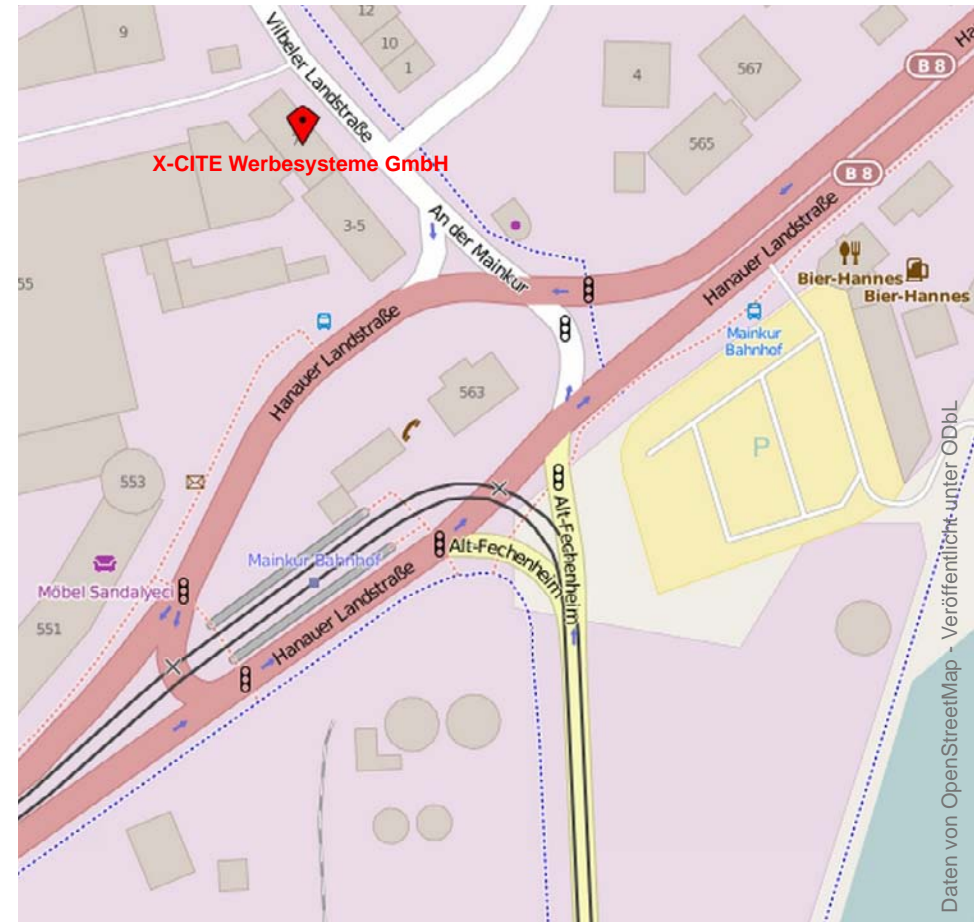

► [In Google-Maps öffnen](#)